

8N260ZLD

Bore 260 mm, Stroke 330 mm

Main Data					
Speed	750 rpm		720 rpm		
Frequency	50 Hz		60 Hz		
Model	Genset. kw	Engine. kw	Genset. kw	Engine. kw	
2000GF	2,000	2,147	-	-	
1950GF	1,950	2,058	1,950	2,058	
Based on alternator efficiency of 95%.					
Specific Consumption					
100% Load	Unit				
Fuel Oil Consumption	g/kWh		188		
Lube oil consumption	g/kWh		0.5 - 0.8		
Dimensions					
Speed	Cyl.	Dimensions (mm) ¹⁾			Dry Mass (ton) ²⁾
		L	B	H	Genset ^{1),3)}
	8	7,900	2,320	3,276	40

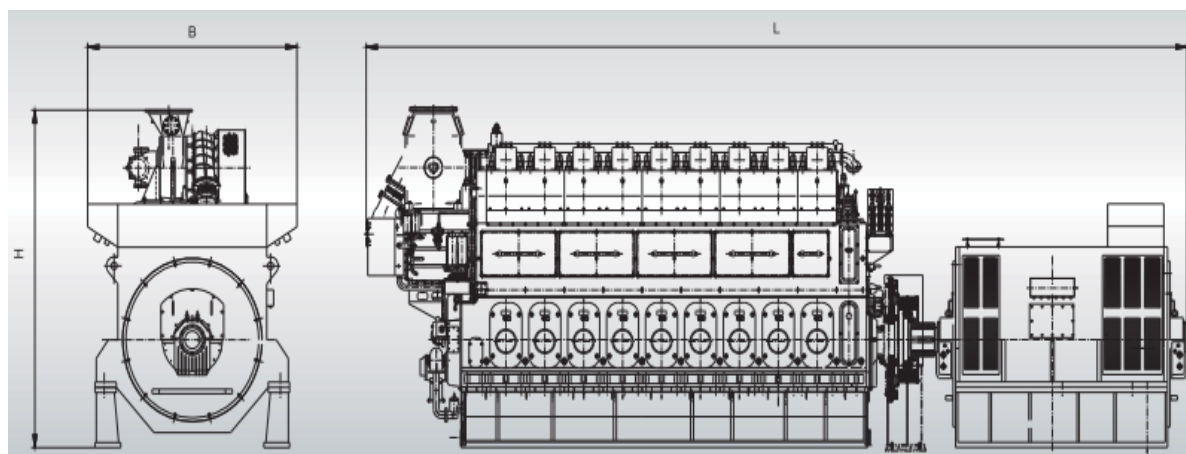

Remarks:

- 1) Depending on alternator.
- 2) Weight included a standard alternator (Maker: ZCP).
- 3) With common base frame & alternator.
- 4) This size is only for reference. The actual size is subject to the size defined in the agreement of the specific project..

URL: <http://www.soarpower.com>

E-mail: sale@soarpower.com

Phone: +86-4008111308